

## JUICE EXTRACTOR Model # 28 & # 58

### USER AND MAINTENANCE MANUAL



**IMPORTANT:** documents included in this manual to be kept:

- "CE" COMPLIANCE DECLARATION
- WARRANTY CERTIFICATE

Translation of the original version



Model # 28



Model # 58

Coffee grinders - Fruit juicers - Mixers - Blenders - Drinks dispensers - Planetary mixers  
- Kneaders - Cheese graters - Ice crushers - Mincers - Vegetable slicers – Dough mixer  
Moulins à café - Presse-fruits - Mixers - Blenders - Distributeurs de boissons - Batteurs  
mélangeurs - Pétrin - Râpes à fromage - Broyeurs à glaçons - Hache-viande - Coupe-légumes

MODELES DEPOSES FRANCE ET INTERNATIONAL  
INTERNATIONALLY PATENTED MODELS





**CONTENTS**

“CE” COMPLIANCE DECLARATION ..... 3

IMPORTANT SAFEGUARDS ..... 4

    INSTALLATION AND HANDLING ..... 4

    IMPROPER USE ..... 4

    ELECTRICAL CONNECTION: ..... 5

    USING FOR THE 1st TIME: ..... 5

    RECYCLING THE PRODUCT AT THE END OF ITS SERVICE LIFE ..... 5

JUICE EXTRACTOR model # 28 & # 58 ..... 6

USING THE APPLIANCE ..... 7

    USING: ..... 7

    HOW TO STOP THE MACHINE ..... 7

    Cleaning: ..... 7

    Precautions and risks: ..... 8

SAFETY / MAINTENANCE ..... 8

    COVER AND BOWL PRESENCE SAFETY DEVICE: ..... 8

    MOTOR OVERLOAD SAFETY FEATURE: ..... 8

    MOTOR OVERHEATING SAFETY FEATURE: ..... 9

    SAFE ACCESS TO THE TOOLS: ..... 9

    MAINTENANCE ..... 9

    SERVICING: ..... 10

FAULT FINDING ..... 11

    The machine will not start: ..... 11

    The machine stops because the motor has overheated: ..... 11

    The machine stops because of an overload: ..... 11

    The machine vibrates when running empty: ..... 11

REFERENCE TO STANDARDS ..... 12

TECHNICAL SPECIFICATIONS ..... 12

ELECTRICAL WIRING DIAGRAMS ..... 13

    Electrical wiring diagram 110 - 120V 50/60Hz ..... 13

    Electrical wiring diagram 220-240V 50/60Hz ..... 14

    FIGURES ..... 16

WARRANTY CERTIFICATE ..... 19

APPLIANCE IDENTIFICATION PLATE ..... 19



## "CE" COMPLIANCE DECLARATION

### THE MANUFACTURER:

**SANTOS SAS** - 140-150, Av. Roger SALENGRO 69120 VAULX-EN-VELIN (LYON)  
FRANCE

declares that the appliance intended for the professional market described below:

Description: **Juice extractor**  
Type number: **28, 58**

complies with:

- the statutory provisions defined in appendix 1 of the European "machines" directive **n°2006/42/CE** and the national legislation transposing it
- the statutory provisions of the following European directives and regulations:
  - N° 2006/95/CE (low voltage directive)
  - N° 2004/108/CE (EMC directive)
  - No. 2002/95/CE (RoHS directive)
  - No. 2002/96/CE (WEEE directive)
  - N° 1935/2004/CE (regulation) relating to materials and articles intended to come into contact with foodstuffs

Harmonised European standards used to give presumption of conformity with the essential requirements of the above-mentioned directives:

- **NF EN 1678+A1: 2010**, Food processing machinery – **Vegetable cutting machines** - Safety and hygiene requirements.  
This European standard is a type-C standard as defined in EN ISO 12100. When the provisions of this type-C standard differ from those stated in the type-A or B standards, the provisions of the type-C standard override the provisions of the other standards. This standard provides the means to comply with the requirements of the "machines" directive n°2006/42/CE, (see appendix ZA)
- **NF EN 12547+A1: 2009 Juice extractor**. Common safety instructions
- NF EN ISO 12100 -1 and 2:2004: Safety of machinery - General principles for design
- NF EN 60204-1: 2006 : Safety of machinery - Electrical equipment of machines- General requirements
- NF EN 1672-2: 2005, Food processing machinery – Basic concepts – Hygiene requirements
- NF EN 60335-1: 2003 : Household and similar electrical appliances. Safety.
- NF EN 60335-2-64 :2004 : Particular requirements for commercial electric kitchen machines

Drawn up in VAULX-EN-VELIN on: **01/01/2010**  
Signatory's position: **CHIEF EXECUTIVE OFFICER**  
Signatory's name: **Aurélien FOUQUET**

Signature:



## IMPORTANT SAFEGUARDS

When using, cleaning or maintaining the machine, always follow these instructions:

Read all instructions

Note: You will find it easier to understand the next few paragraphs if you refer to the diagrams at the end of this manual.

### INSTALLATION AND HANDLING

#### CAREFUL:



**For all handling operations including unpacking the machine, the cover clamping handle (1) must not be used for holding or lifting the appliance.**

The machine can be handled by a single person. It is recommended that the appliance be placed on a table or worktop for more comfortable use, so that the juice outlet spout and the On (11) and Off (12) buttons are in front of you (recommended height: 90 cm, to be adapted as required for the user).

During cleaning and installation, handle the basket assembly (5) carefully so as not to put it out of shape thus preventing the machine from working properly.

### IMPROPER USE



1. Do not place food in the channel and press with the plunger before you have started the machine.
2. The appliance is not designed for handling frozen foods.
3. Remove stones from fruit before processing it in the machine (e.g.: mangoes, apricots, peaches). Do not let the stones go into the machine.
4. Neither a hose nor a pressure hose should be used for cleaning
5. The machine must not be left to operate without supervision.
6. Do not use abrasive sponge for cleaning the basket
7. The appliance must not be used on any surface which has a slope of more than 10° relative to horizontal. The machine's 4 feet must always be resting on that surface. The machine's motor spindle must always be vertical relative to that surface.
8. Use of spare parts other than certified original SANTOS parts is prohibited.
9. This appliance is not designed for use by people (including children) whose physical, sensorial or mental capacities are impaired or by people with no experience or knowledge, unless they have been supervised or given training in the use of the appliance beforehand by a person responsible for their safety. Supervise children to ensure they do not play with the appliance.



## ELECTRICAL CONNECTION:

The appliance is available in with a choice of two voltages for the power supply

- 220-240V 50/60 Hz single phase
- 100V 50 Hz - 120V 60 Hz single phase

Line protection: the appliance should be connected to a standard 2-pole + earth electric socket. The installation should be fitted with an RCD and a fuse rated at 16A. **The appliance must be earthed**

### CARE:



- Before connecting the machine, check that the mains electrical voltage is the same as the voltage for your appliance. Its value is shown:
  - either on the identification plate under the machine.
  - or on the identification plate on the last page of this manual.
- If the power cable (10) is damaged, it should be replaced by a special assembly available from approved SANTOS dealers or from SANTOS.

## USING FOR THE 1st TIME:

1. Remove the plunger (3).
2. Rotate the clamping handle (1) by one half turn to release the cover (2), Fig.2
3. To be able to remove the cover, turn then lift the cover (2), Fig.3
4. **Model # 28** : Using the basket locking spanner (18), unscrew the basket fixing screw (15) completely, while holding the basket immobile with the other hand. Fig.4
5. Raise the bowl (4). The basket (5) should come out of its seating. Fig.5
6. Remove the basket assembly (5) and wash in clean water.
7. Wash all the elements in contact with food in clean water: the plunger (3), the cover (2), the bowl (4) and the pulp container (6). Fig.6

### Installing the product discharge channel

1. Place the discharge channel (16) on the bowl (4).  
Insert and screw tight the 2 screws (17) on the bowl pins (4). Fig.7

## RECYCLING THE PRODUCT AT THE END OF ITS SERVICE LIFE



This equipment is marked with the selective sorting symbol relating to wastes from electrical and electronic equipment. It signifies that this product should be taken over by a selective collection system conforming to the Guideline 2002/96/EC (WEEE) – part Professional Equipment – so that it can be either recycled or dismantled in order to reduce any impact on the environment.

For more information, please contact your Retailer or the SANTOS.

For eliminating or recycling components of equipment, please contact a specialized company or contact SANTOS.





The electronic products not undergoing a selective sorting are potentially dangerous for the environment.  
The damaging materials should be eliminated or recycled according to the regulations in force.

## JUICE EXTRACTOR model # 28 & # 58

- Robust and very well-constructed (components made of cast aluminum, engineered plastic and 18/10 stainless steel plate), this juice extractor is particularly suitable for extracting juice and making coulis and sauce juices from fruits or vegetables used by the professionals in:  
Restaurants, Pizzerias, Snack Bars, Fast Food Outlets, Special Theme Restaurants, etc.
- It has a powerful motor which drives a **centrifugation basket**.
- **Centrifugation basket:** The active, filtering part of the basket is made of stainless steel.  
**Model # 58** : the bottom part of the basket providing the drive and the locking system is made of food quality engineered plastic.
- 18/10 press-drawn stainless steel **bowl** with stainless steel spout for collecting and funneling the product juices.





## USING THE APPLIANCE

### USING:

#### Assembly and preparation:

1. **Fit the bowl (4)** on the bowl centering device (7) making sure that the juice run-off spout is located in the indent provided for that purpose in the bowl centering device (7) Fig.8
2. **Model # 28 : Place the basket assembly (5)** in the bowl (4), making sure it is correctly located on the motor shaft (8). The drive pin (19) needs to be in the grooves in the basket assembly (5). Fig.9  
**Model # 58 : Place the basket assembly (5)** in the bowl (4), making sure it is correctly located on the motor shaft (20). The drive pin (22) should enter the notches of the basket assembly (5). Fig.9
3. **Model # 28 : Using the spanner (18)** insert the basket locking screw (15) and screw it tight. During this operation, the basket shifts downwards a few millimeters. During the locking operation the basket can be held with one hand.
4. **Place the cover (2)** on the bowl (4), turn the cover to engage the 2 lugs in the catches on the locking rods. Fig.10
5. **Rotate the clamping handle (1) by one half turn** to block and lock the cover in place (2), Fig.5
6. **Place the fruit plunger (3)** in the cover feed channel (2) Fig.11
7. **Position the pulp container (6)** correctly relative to the outlet of the discharge channel (16).
8. **Connect the supply cord plug (10)** to your mains supply socket. Fig.12
9. **Withdraw the fruit plunger (3)** from the cover feed channel (2).

#### Using:

1. **Start the machine** by operating the On button (11).
2. **Place the recipient** under the bowl spout (4)
3. **Introduce the fruits or vegetables** into the cover feed channel (2) and push them onto the rotating grater with the fruit plunger (3).
4. Continue this operation until the juice recipient is full or all the fruit and vegetables to be processed have been used. Also keep an eye on the level of pulp in the pulp container (6).

### HOW TO STOP THE MACHINE

The appliance is stopped:

1. by pushing the Off button (12),
2. or by turning the clamping handle (1) from the back to the front.
3. or by unplugging the mains cord plug (10)

### Cleaning:



**Handle the basket assembly (5) carefully so as not to put it out of shape thus preventing the machine from working properly.**

To clean the basket assembly (5), it is recommended to use the brush (25) supplied with the machine, for proper cleaning of filter sieve holes and the grater teeth. Fig. 15. Do not use abrasive sponge for cleaning the basket.

Cleaning will be easier if you do not wait for the food remains to dry in the bowl, basket and cover.

### Precautions and risks:



During preparation, **the level in the pulp container (6)** should be monitored to prevent the cover pulp outlet (2) from clogging. Such clogging could result in an imbalance in the basket assembly (5) and thus a risk of damaging the machine.

The quantity of products to be processed before reaching the maximum filling level in the container (6) varies according to the products being processed.

If during preparation an imbalance should occur well before the pulp container is full, it is sometimes appropriate to continue adding food for the imbalance to be cleared.

But if the imbalance continues, the machine must be stopped and the basket assembly (5) cleaned. Certain products are liable to clog or block the sieve holes, in which case the basket assembly (5) should be cleaned more frequently..

## SAFETY / MAINTENANCE

### COVER AND BOWL PRESENCE SAFETY DEVICE:

For the juice extractor to be able to start, the cover (2) and the bowl (4) must be centered in position on the bowl centering device (7) and held by the clamping handle (1).

Putting the clamping handle in the vertical position (up) without the bowl or without the cover means that the machine cannot be started.

### MOTOR OVERLOAD SAFETY FEATURE:

#### **Models 220-240V 50/60Hz**

Should the motor become blocked (foreign body, object that is too hard, too much pressure with the fruit plunger on the products being processed), the **circuit breaker (14)** located under the appliance triggers and cuts off the power supply to the motor. Fig.13  
Correct the fault, reset the circuit breaker and re-start the machine.

If the problem persists, switch off the power supply to the machine (unplug the cord from the mains socket (10)) and call in the maintenance service or contact a SANTOS approved dealer.





**Models 110-120V 50/60Hz**

Should the motor become blocked (foreign body, object that is too hard, too much pressure with the fruit plunger on the products being processed), the **motor overheating safety feature** triggers and switches off the motor (see overheating safety feature).

**MOTOR OVERHEATING SAFETY FEATURE:****Models 110-120V 50/60Hz only**

In the event of the motor overheating, the appliance stops automatically.

The safety feature has an automatic reset, so wait for the motor to cool (15 to 30 minutes), before restarting the machine.

If the problem persists, switch off the power supply to the machine (unplug the cord from the mains socket (10)) and call in the maintenance service or contact a SANTOS approved dealer.

**SAFE ACCESS TO THE TOOLS:**

The juice extractor can only be started if the cover and bowl are positioned correctly on the bowl centering device (7) and the clamping handle (1) is locked.

Releasing the clamping handle (1) results in the machine stopping and the immobilization of the rotating elements in less than 3 seconds.

Re-starting the juice extractor requires specific operation of the On switch (11) again. A cut in the mains power supply makes the machine stop.

**MAINTENANCE**

Before carrying out any work on the juice extractor, the machine must in all cases be unplugged from the mains power supply and the motor start capacitor discharged:

**Discharging the capacitor:**

Use a screwdriver with insulated handle to touch the 2 connectors on the capacitor (13). The appearance of an electric arc shows that the capacitor has discharged. Fig.14

**Spare Parts :**

**IMPORTANT:** Use of spare parts other than certified original SANTOS parts is prohibited.

This machine requires no particular maintenance because the bearings are lubricated for life.

If any intervention is necessary to replace parts subject to wear, such as the grater, the basket, electrical or other components, please refer to the parts list (see the exploded



view at the end of this manual, or that can be downloaded from our Web site [www.santos.fr](http://www.santos.fr)).

For the machine to operate properly, it is recommended that a check is also made that the locking membrane (21) is in good condition, in particular the absence of any signs of tearing. Also check that the elastomer drive sprockets (22) are in good condition, in particular the absence of any signs of wrenching.

For **all spare part orders** (see references in the exploded view at the end of the manual), state the **type, the appliance serial number and the electrical specifications recorded under the appliance.**

### SERVICING:

**Neither a hose nor a pressure hose should be used for cleaning**

- After use, clean the basket assembly, bowl, cover, pulp container, plunger in clean water or with a dish washing detergent product designed for this purpose. Then rinse and dry. **Do not use abrasive products or pads** to clean the basket assembly.
- The base is to be cleaned with a soft damp sponge, then dried.

### **TAKE CARE:**



**For easier cleaning, do not leave food remains to dry on the bowl (4), the basket assembly (5), the cover (2), or the fruit plunger (3). It is recommended that all these parts of the machine are cleaned immediately after the work is finished.**





## FAULT FINDING

First identify exactly why the machine stopped.

### The machine will not start:

- Check: the mains power supply and the condition of the power supply cord,
- Check: the position of the juice bowl (4) on the bowl centering device (7), the position of the cover (2) on the juice bowl, and the locking of the clamping handle (1).

### The machine stops because the motor has overheated:

(the metal casing around the motor unit is hot)

- Remove the plug from the power supply socket and follow the instructions in the section on "motor overheating safety feature".

### The machine stops because of an overload:

- see the section on "motor overload safety feature"

### The machine vibrates when running empty:

This vibration is caused by an imbalance. This imbalance may be caused by:

- The basket (5) being positioned incorrectly: check it is correctly positioned
- Distortion of the basket (5), check and replace if necessary.



## REFERENCE TO STANDARDS

- CE (Europe)
- GS (Germany) checked by the LNE National Test Laboratory.
- UL (USA) and cUL (Canada).
- NSF (USA).

## TECHNICAL SPECIFICATIONS

<b>Mains power supply:</b>		
Power supply voltage (V)	220-240	100 / 120
Frequency (Hz)	50 / 60	50 / 60
Start capacitor (µF)	80µF 260V	180µF 160V
Overload safety device (A)	8	15
Start relay (SANTOS reference) Model #28 / Model #58	28505 / 58505	28505B / 58505B
<b>Motor:</b>		
Rating (kW)	1.3	1.3
Power requirement (A)	5	14.5
Motor speed (rpm)	3000 / 3600	3000 / 3600
Time for machine to stop	3 secs max	3 secs max
<b>Noise LAeq, dB</b> Measured at 3000 rpm ref 20µPa	75	75
<b>Dimensions and weight</b>		
Height (mm) Model #28 / Model #58	510	
Width (mm)	465	
Depth (mm)	330	
<b>Net weight (kg)</b>	24	
<b>Packaged weight (kg)</b>	26.7	
Container capacity (Liters)	7.5	
Bowl spout height (mm)	222	
Temperature of products processed	Min: 4°C	Max: 120°C



# ELECTRICAL WIRING DIAGRAMS

Electrical wiring diagram 110 - 120V 50/60Hz

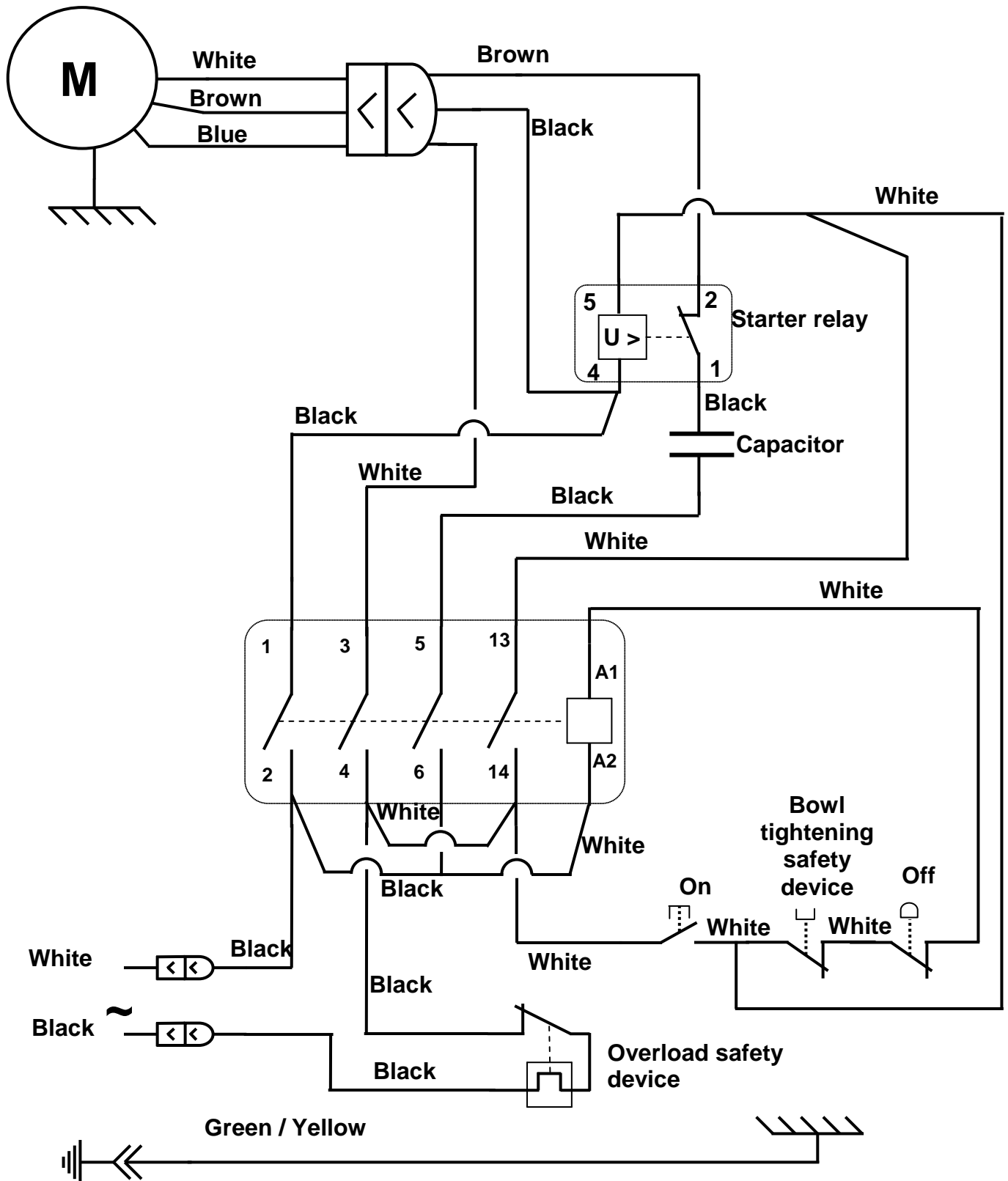

Electrical wiring diagram 220-240V 50/60Hz

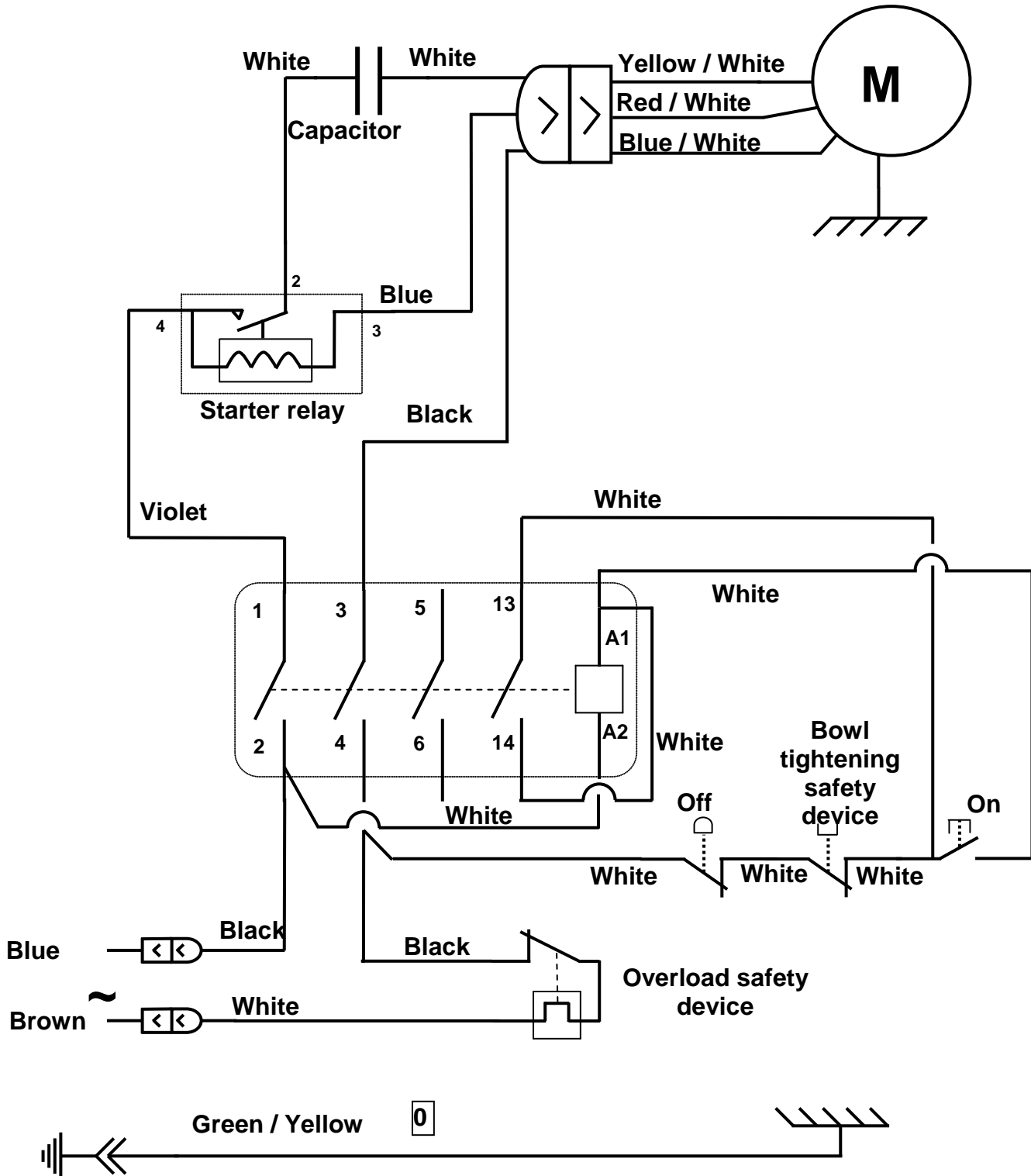



## TABLEAU DE TRADUCTION DES ELEMENTS DE LA MACHINE

item	EN	F
1	Clamping handle	Poignée de serrage
2	Cover	Couvercle
3	Plunger	Poussoir
4	Bowl	Cuve
5	Centrifugation basket	Panier centrifugation
6	Pulp container	Conteneur à pulpe
7	Bowl centering device	Centreur de cuve
8	Motor shaft	Axe moteur
9	Clamping rod	Tige de serrage
10	Power supply cord	Cordon alimentation
11	Start button	Bouton poussoir Marche
12	Stop button	Bouton poussoir Arrêt
13	Capacitor	Condensateur
14	Overheat safety device	Protecteur surchauffe
15	Basket screw	Vis de Panier
16	Discharge channel	Goulotte d'évacuation
17	Bowl nut	Ecrou de cuve
18	Basket locking spanner	Clé de serrage de Panier
19	Drive pin	Goupille d'entraînement
20	Motor shaft	Tête d'entraînement
21	Membrane	Membrane
22	Drive pin	Pion d'entraînement
23	Grater	Râpe
24	Identification plate	Plaque signalétique
25	Basket cleaning brush	Brosse de nettoyage du panier



**FIGURES**



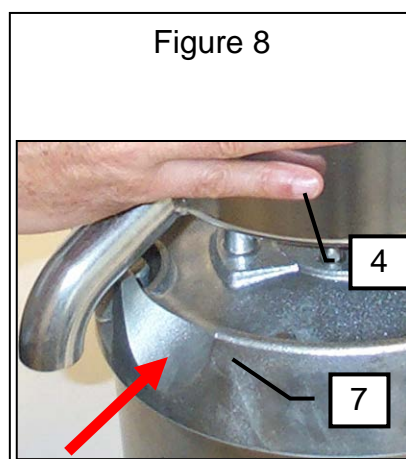
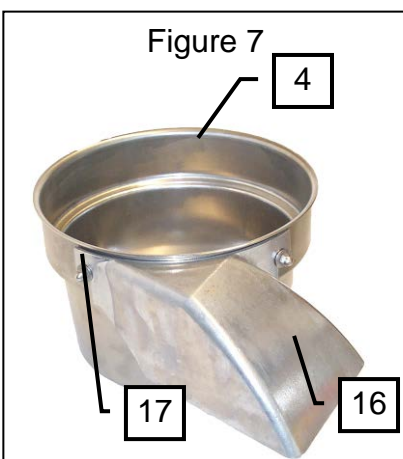
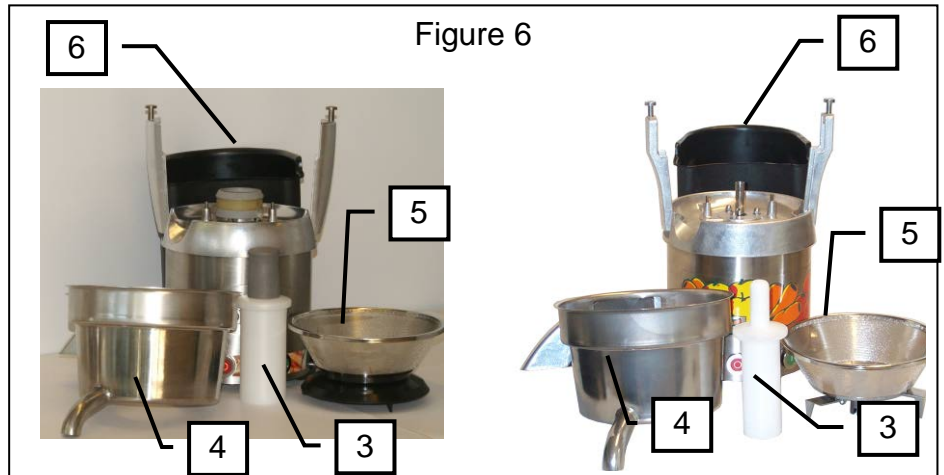
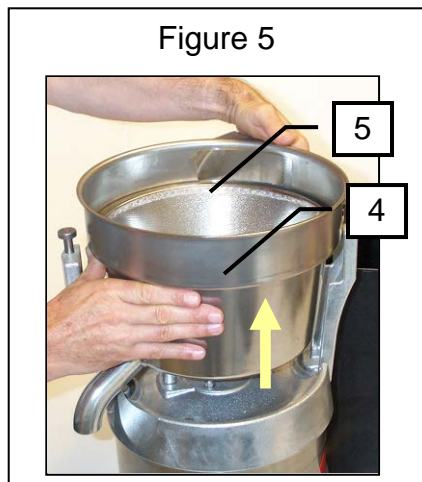
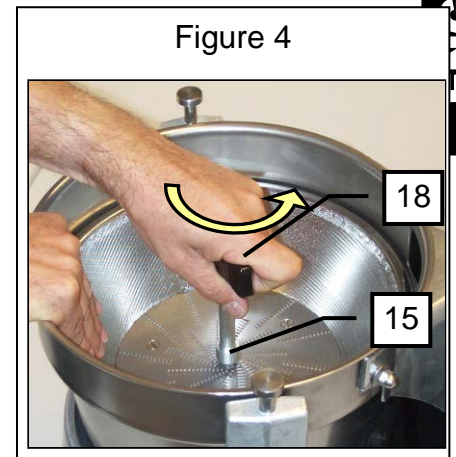
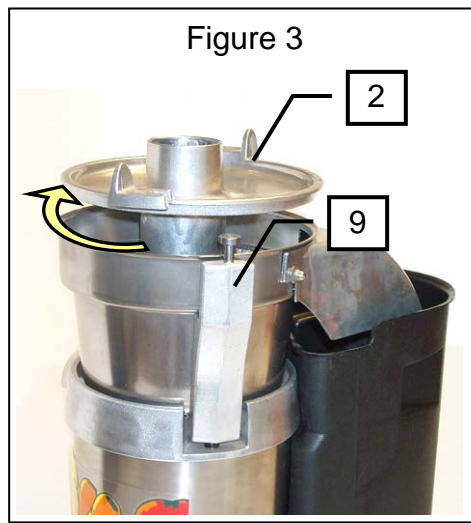
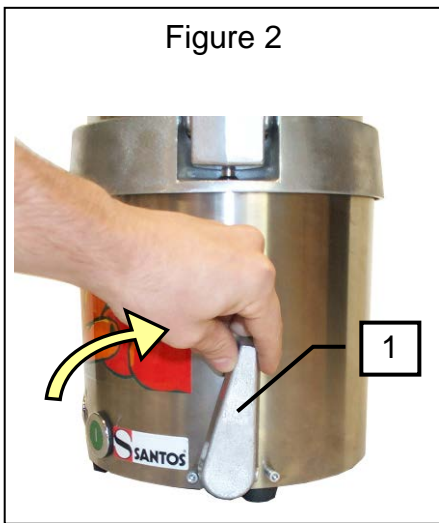



Figure 9

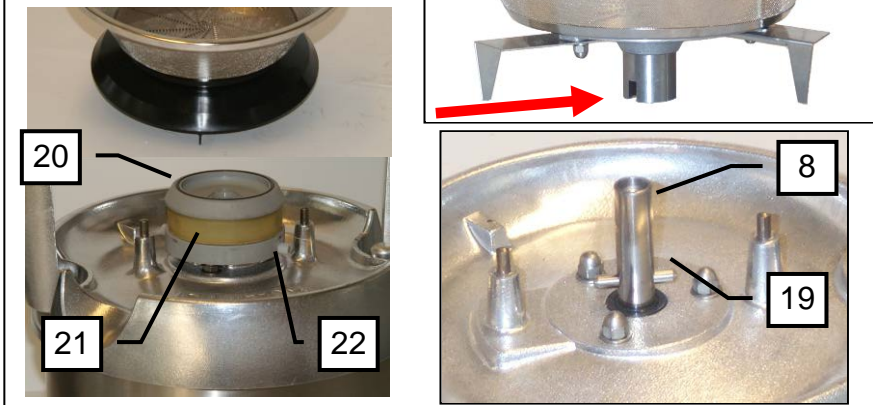

Figure 10



Figure 11



Figure 12

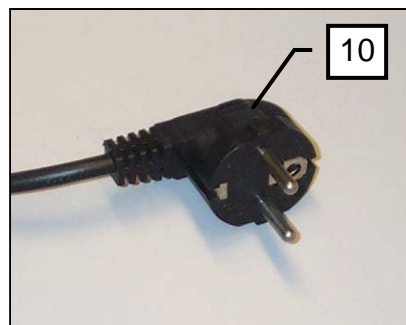

Figure 13

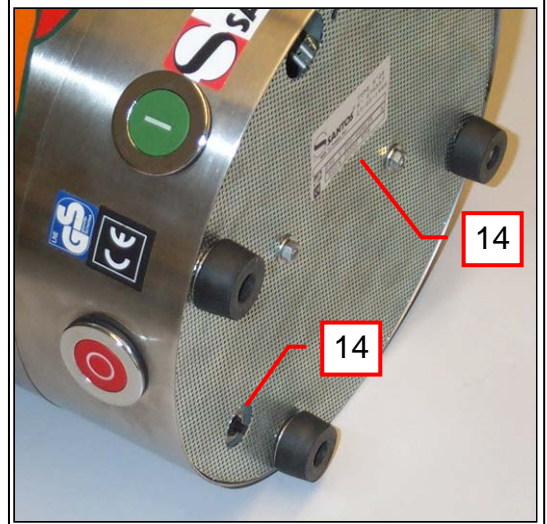

Figure 14

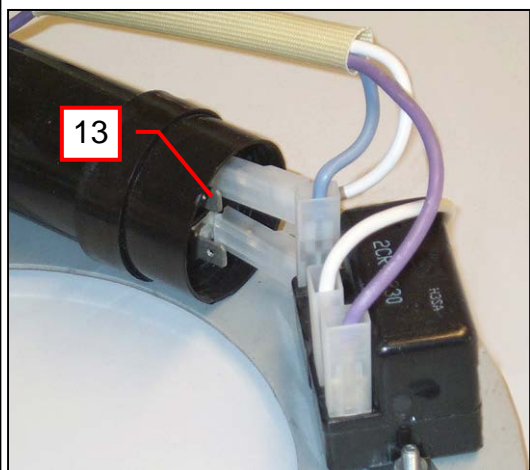
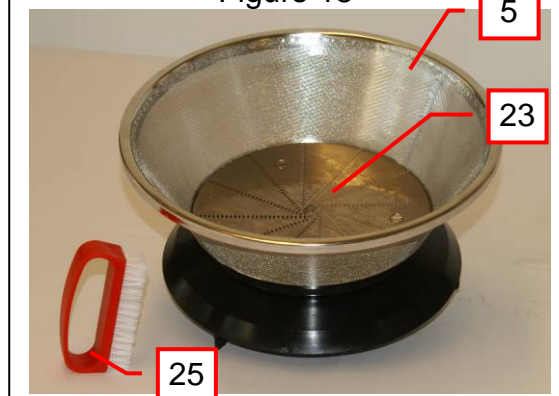

Figure 15



## WARRANTY CERTIFICATE

### WARRANTY

Since the 01.01.95, all our appliances comply with CE and possess the CE label. Our guarantee is of 24 months from the manufacturing date mentioned on the descriptive plate, except concerning the asynchronous motors (consisting of a rotor and a stator) which are warranted for 5 years from their manufacturing date. Warranty is strictly limited to the free replacement of any part of origin recognized by us as defective due to a defect or building default and identified as belonging to the concerned appliance. Warranty does not apply to damages resulting from installation or use non-complying with our appliance data sheet (user's manual) or in case of an evident lack of maintenance or disrespect of elementary security electric rules. It does not apply in case of regular wear and tear. Any replacement of parts under warranty will be realized after return of the defective part in our workshops, postage paid, supported by a copy of a conformity statement on which appears the serial number of the appliance. Every appliance is equipped with a descriptive plate conforming to the EC recommendations and of which a duplicate exists in the conformity statement (serial number, manufacturing date, electrical characteristics ...). In case of serious damage judged repairable only in our workshops, and after prior consent from our departments, any appliance under guarantee is sent by the Distributor, carriage paid. In case of repairs or reconditioning of appliances not under guarantee, the round trip transport is payable by the distributor. The parts and workforce are invoiced at the current rate. A preliminary estimate can be supplied.

Coffee grinder not using SANTOS original burrs are not taken under guarantee. The warranty conditions, repairs, reconditioning, of the espresso coffee grinder are the object of a specific note. Our guarantee does not extend to the payment of penalties, the repair of direct or indirect damages and notably to any loss of income resulting from the nonconformity or the defectiveness of products, SANTOS's global responsibility being limited to the sale price of the delivered product and to the possible repair of the defective products.

In case of revelation of an imperfection during the warranty period, the Distributor has to, unless a different written agreement of SANTOS, indicate to his customer to stop any use of the defective product. Such a use would release SANTOS of any responsibility.

## APPLIANCE IDENTIFICATION PLATE

